

Installation Manual

Block Programmable Receiver 800/1600 Users SEL2641R433-K8/K8P/K16P

We appreciate your choice of this product.

*This product is addressed to manage the access in
automatic door control systems*

This appliance has been carefully manufactured and checked.

*The manufacturer has designed this system to assure the best reliability and
satisfaction in the time*

We recommend to read carefully this manual before to proceed to the installation



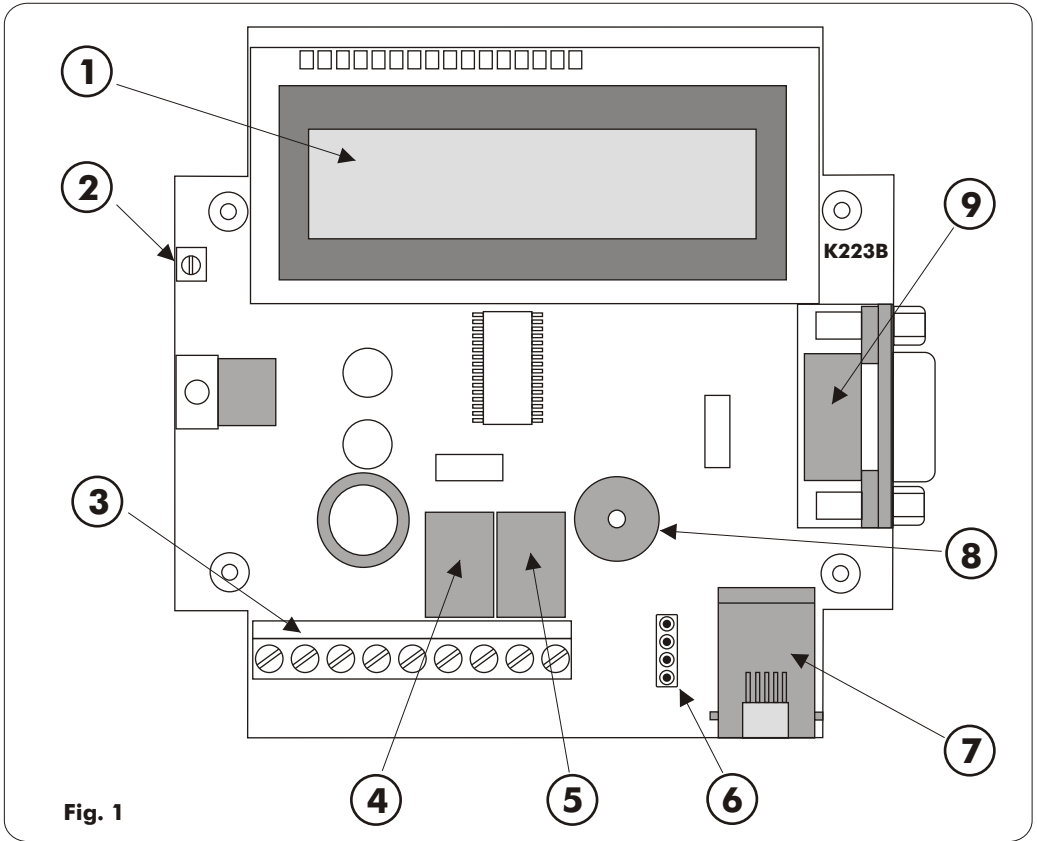

Legend

- 1 : Backlighted LCD display
- 2 : LCD trimmer adjust
- 3 : Terminal boards
- 4 : Relay1
- 5 : Relay 2
- 6 : 4 pin strip connector
- 7 : RJ11 phone connector
- 8 : Buzzer
- 9 : D-type 9 pin male connector
- 10 : Plugs
- 11 : Screws
- 12 : Aerial net
- 13 : Receiver box

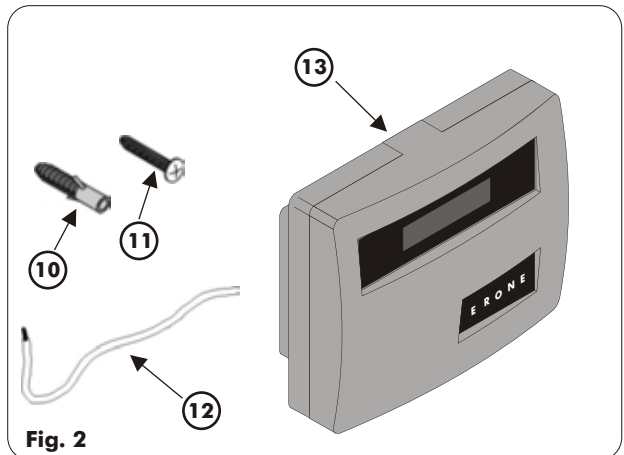

Contents

Important Recommendations	Pag. 4
General Remarks.	Pag. 4
Receiver composition	Pag. 4
Versions	Pag. 4
Technical specifications	Pag. 4
Compatibility	Pag. 5
Introduction	Pag. 5
MASTER transmitter use guide	Pag. 5
USER transmitter use guide	Pag. 5
KEYPAD use guide	Pag. 5
Installation	Pag. 6
Electrical connections	
Transmitters programming	Pag. 7
MASTER transmitter memorization	
USER transmitter memorization	
Main menu structure	
Menu Delete	Pag. 9
Single user cancellation	
All users cancellation	
Complete initialization of the receiver	
Menu Modify user	Pag. 10
Enable / Disable	
Modify relay or key parameters	
Copy and data transfer menu.	Pag. 11
Memory Visualization on the LCD	
Print user list	
Print events	
Transmitter S/N configuration	
Data transfer from and to a backup device	
Receiver configuration menu	Pag. 15
Change Password	
Relay configuration (Relay1 - Relay 2)	
Facility Code set-up (Facility Code 1 - Facility Code 2)	
Receiver auto-test system	Pag. 17
RS232 Connections	Pag. 18
Accessories	Pag. 19

Important recommendations

- Never interfere with the product when connected to a power source;
- Avoid direct contact with water;
- Regularly check the state of the product;
- Respect the current norms;
- Wear protected glasses to avoid injury during the drilling phase;
- Change the factory code;

General remarks

Radio

The materials and the technology used have made it possible to create a system functioning on the 433,05 - 434,790 MHz frequency band, used by LPD equipments and therefore subject to European radio and electromagnetic compatibility regulations (CE).

Rolling Code

In order to guarantee your safety and the total inviolability of the communication between transmitter and receiver, the code sent out by the transmitter changes every time the equipment is used and is recognised by the receiver only, thanks to an unfalsifiable code-setting calculation. The system thus conceived avoids all risk of being recording or of the code being copied (268 million combinations).

Composition of the receiver

See fig. 2

Item	Description	Q.ty
1	Receiver	1
2	Antenna wire	1
3	Assembly screws	4
4	Plugs	4

Versions

SEL2641R433-K8	RX 800 Users
SEL2641R433-K8P	RX 800 Users PCCOM (*)
SEL2641R433-K16P	RX 1600 Users PCCOM (*)

(*) PCCOM : Internal firmware with predisposition for the connection to a PC with Software PCCOM

Technical specifications

● Receiver

Carrier frequency	433,92 MHz
Local oscillator freq.	6,6128 MHz
Power supply	12/24 Vac/dc
Modulation	AM/ASK
Number of memorizable users	812 - 1631 (*)
Number of relays	2
Type of output contact	1 NO, 1 NO/NC
Commutable power	24 VA
Maximum relay voltage	60 V
Absorbion	95 mA (relay excited)
Housing protection	IP 40
Operating temperature	from -10°C to +55°C
Overall dimensions	180x140x68mm
Weight	330gr

(*) According to the version

● Transmitter Types E2-E4-E2M

Operating Frequency	433,92 MHz
Power supply	12 Vdc
Modulation	AM/ASK
Number of functions	2 or 4
Coding type	Rolling Code
Number of combinations	2 ⁶⁴
E.r.p.	100 - 200 μW
Absorbion	18 mA
Range in open space with receiver with antenna	100-200 meters
Housing protection	IP 44
Operating temperature	-10°C to +55°C
Dimensions	82x48x16 mm
Weight	32gr
Battery type	Alkaline - 23A

Compatibility

Look at the following table for the compatibility between the receiver and the different series of Erane Transmitters

Receiver	Transmitters
SEL2641R433-KX	S2TR2641E2 - E4 - E2M (Series 024A) SETR2641AM2 (Series mini AM) SEDK2641A4 (Digikey)

Introduction

This receiver allows to manage 800 pre-coded transmitters (2 or 4 keys) for a wireless access control system.

There are 2 output relays with NO and NC/NO contacts.

The managing of the users is fully wireless: the receiver can be programmed by using a special transmitter called "MASTER transmitter".

This is memorized during the first installation.

The internal EEPROM allows to memorize up to 7 MASTER transmitters.

All the operations are displayed through a 16x2 backlit LCD display.

The menu is friendly and very easy.

Master transmitter use guide

Each MASTER transmitter allows to set the receiver using just 2 keys.

The transmitter keys can have different meanings depending upon the phase, as shown in the following examples:

Answer to a question

NO

Activation of the **LEFT** key
Answer **NO** to a question



YES



Activation of the **RIGHT** key
Answer **YES** to a question

Number setting

Activation of the **LEFT** key
Cyclical scroll upwards a digit



Activation of the **RIGHT** key
Gives confirmation to the present digit and shifts the cursor to the next digit of the number.

Menu managing

Activation of the **LEFT** key
Cyclical scroll of the available options of a menu



Activation of the **RIGHT** key
Confirm the choice and entry into the lower menu



Simultaneous activation of the both keys
LEFT and **RIGHT** : Back to the previous menu

User transmitter use guide

The standard transmitters (called USER Transmitters) are memorised making use of the MASTER transmitter (in single mode or by blocks).

The USER transmitter keys activate the relays according to the memorised configuration.

During the normal use, the simultaneous activation of both the keys of the transmitter is disabled.

This facility is only used during the programming procedure (see pag. 8).

Keypad use guide

The receiver can be programmed using the transmitter DIGIKEY, called KEYPAD.

See. Fig. 3 the correspondence between the transmitter keys and the Keypad keys.

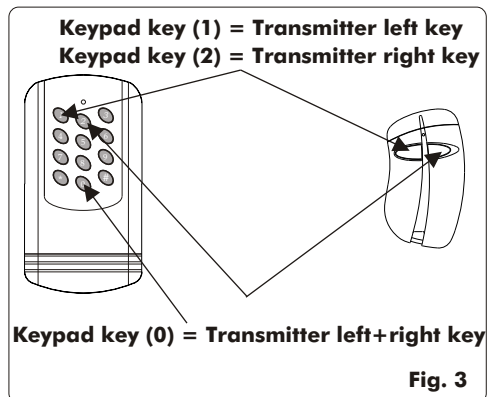

Installation

- Position the receiver on a plane, open it and remove the pre-forated parts (fig. 4) situated at the back of the receiver with the aid of a screwdriver.
- Make a hole in the pre-forated parts (5) (fig. 6).
- Put the plugs in the holes (fig. 7) or adapt the holes to the nature of the support.
- Fix the receiver using the screws supplied (fig. 8).
- Make holes in the guiding slits (only in those used), and thread the wires through the guiding slits (fig. 9).

ERONE advice

When assembling the equipment outdoors, we advise you to protect the receiver in a container with an IP54 level of protection.

Electrical connections

ERONE advice

A telephone wire (0.6 mm²) is sufficient for the input of the receiver and the relay cabling.

Receiver power supply:

- connecting clip 3: 0V
- connecting clip 4: 12/24 Vac/dc

Connect the output contacts:

- connecting clip 5: common relay 1
- connecting clip 6: NO contact relay 1 (contact normally open)
- connecting clip 7: common relay 2
- connecting clip 8: NO contact relay 2 (contact normally open)
- connecting clip 9: NC contact relay 2 (contact normally closed)

Connect the antenna

- connecting clip 1: antenna conductor or antenna wire supplied with the receiver

ERONE advice

The installation and positioning of the antenna are fundamental for good reception. Carry out tests before fixing the antenna definitively. Place the antenna as high as possible and far from all types of metal structures which could shield the receiving part of the antenna.

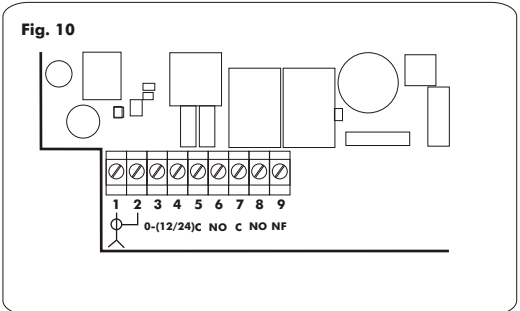
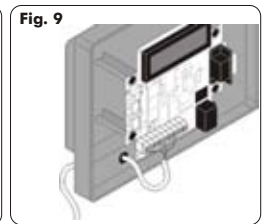
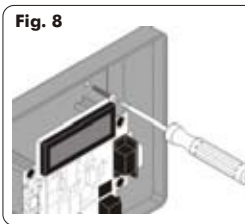
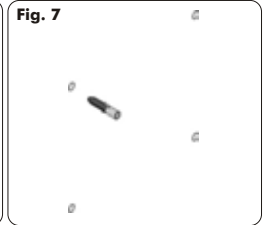
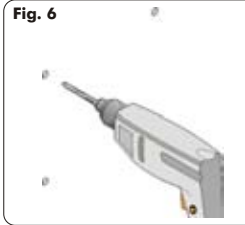
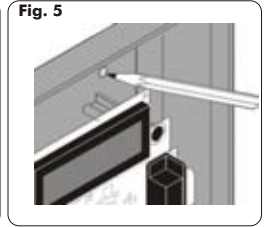
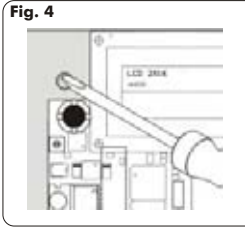

Transmitter programming

The configuration of the receiver is possible only after the memorization of one or more MASTER transmitters.
If the memory is empty, follow the following procedure:

Connect the power-supply and switch on the receiver. On the display will appear the initial message.

The initial message can be different depending upon the password configuration (see procedure on pag. 15 for the password setting).

The receiver is sold with a default value of the password : (“11111”).

E	R	O	N	E				4	3	3	/	8	0	0		



This symbol stands for “Password enabled” See pag. 15

(*) : The welcome message changes according to the version

E	R	O	N	E				4	3	3	/	8	0	0		
					W	E	L	C	O	M	E					

If the initial message has the “Welcome” instead of the key symbol, it means that the password has been reset (“00000”).

MASTER transmitter memorization

Push simultaneously the keys LEFT and RIGHT of a MASTER transmitter .

On the display appears the following message:

S	N	0	0	0	0	E		R	L	½		K	Y	A		
S	T	O	R	E		M	A	S	T	E	R	?				

Where 00000 is the Serial Number of the Master transmitter used.

With an answer YES, the display shows “ EXECUTED OK” and the transmitter is memorized.

On the first line of the display is present the information of the abilitation of the whole transmitter, the relays activated (1 or 2 or ½” both”) and the corresponding transmitter keys : see pag. 10.

With an answer NO there is the return to the initial message.

Main menu structure

The menu is organized into different levels, with a main level and several lower levels. Once composed the right password you enter into the main level.

See below the structure of the main level with the different lower options.

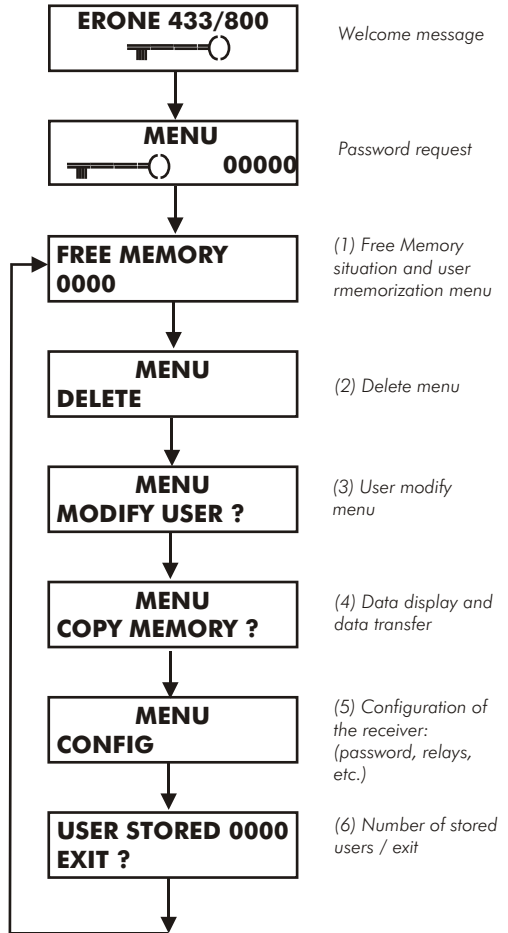

USER transmitters memorization

The procedure begins at point (1) of the main menu.

S	T	O	R	E		U	S	E	R		M	E	N	U	
U	S	E	R				S	N			0	0	0	0	1

The cursor blinks under the first left digit of the Serial Number to set.

For this operation there you can use 3 different methods:

1) With the TX MASTER

Scroll up the digit with the LEFT key (cliclically) and shift right to confirm with the RIGHT key.

Push LEFT + RIGHT keys simultaneously to cancel and to go back to the upper menu;

2) With the KEYPAD

Use the keys of the keypad to set the right number and shift right to confirm with the key (#);

3) With the TX USER

Push the key B of the USER transmitter which has to be memorized: its Serial Number will replace the default number of the message. Then push the RIGHT key of the MASTER transmitter.

Once set (for instance) the S/N : 20160, as explained above, the program will ask for the relay [1, 2 or ½] and the keys configuration [A,B,C,D].

U	S	E	R			S	N			2	0	6	1	0
R	E	L	A	Y	:	½				K	E	Y	:	A

Modify the parameters RELAY and KEY according to your needs by using the MASTER transmitter.

The next step allows to choose a "single" or a "block" memorization.

U	S	E	R			S	N			2	0	6	1	0
S	T	O	R	E		S	I	N	G	L	E	?		

With an answer "YES" to the above question this phase ends and the message "EXECUTED OK" appears on the display.

With an answer "NO" begins the procedure for the block memorization: the display will show the S/N of the first transmitter of the block.

The next question proposed is the number of transmitters of the block.

U	S	E	R			S	N			2	0	6	1	0	
H	O	W		M	A	N	Y		T	X		0	0	0	0

Enter the number of TX with the TX MASTER

S	T	O	R	E		0	0	0	0		T	X		
A	R	E		Y	O	U		S	U	R	E	?		

Give the confirmation with the RIGHT Key of the MASTER transmitter.

NOTE :

If the memory contains already any transmitter with S/N included in the range of the block, the entire operation is cancelled and on the display appears the following message:

S	N		X	X	X	X		R	L	X		K	Y	X
S	E	R	I	A	L		E	X	I	S	T	!		

Where XXXX is the Serial Number of the transmitter already present in the memory, RL X is the relay activated and KY X is the transmitter key associated.

Menù : Delete

This procedure begins at the point 2 of the main menu.

Through this procedure it is possible to delete:

- A single USER
- All the USERS
- The whole memory (Complete initialization of the receiver memory)

The structure of this sub-menu is the following:

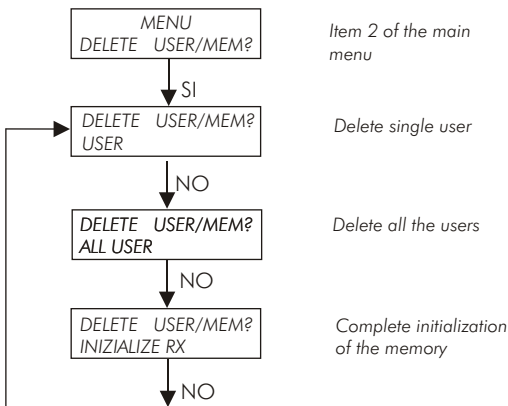

Item 2 of the main menu

Delete single user

Delete all the users

Complete initialization of the memory

Use the LEFT key of the MASTER transmitter to scroll the different choices and select the operation to do with the RIGHT Key.

Use both keys of the MASTER transmitter to return back to the main menu.

Single user cancellation

With this choice you are asked for the Serial Number of the transmitter to delete:

D	E	L	E	T	E			U	S	E	R	/	M	E	M			
U	S	E	R					S	N					2	0	6	0	9

Entry the S/N using one of the methods of pag.8 (TX Master, KEYPAD or key B of the transmitter to delete , where possible).

Finally will appear the message:

D	E	L	E	T	E			S	N					2	0	6	0	9
A	R	E		Y	O	U		S	U	R	E							

In this case with an answer YES the transmitter with S/N 20609 will be deleted and both the parameters "free memory" and "stored TX number" will be updated.

All users cancellation

This option allows to delete all the USER transmitters and to keep in the memory the MASTER transmitters.

D	E	L	E	T	E			U	S	E	R	/	M	E	M		
A	L	L		U	S	E	R		?								

A further confirmation is required to finish the procedure

D	E	L		A	L	L		U	S	E	R						
A	R	E		Y	O	U		S	U	R	E		?				

With a final YES, the cancellation will be carried out the message "EXECUTED OK" appears on the display and the receiver returns to the initial message.

Complete initialization of the receiver

With this option the following actions are carried out:

- cancellation of all the USER transmitters;
- cancellation of all the MASTER transmitters;
- cancellation of the current password and restore of the default password ("11111").
- Restore at "0800 / 1619" of the free memory number
- Reset to "0000" of the stored transmitter number.

D	E	L	E	T	E			U	S	E	R	/	M	E	M		
I	N	I	Z	I	A	L	I	Z	E		R	X		?			

With the answer YES you are asked for a further confirmation:

I	N	I	Z	I	A	L	I	Z	E		R	X					
A	R	E		Y	O	U		S	U	R	E		?				

With a final YES the memory is completely cancelled, the message EXECUTED OK appears and the receiver returns to the initial message.

Menu : Modify User

This procedure is at the item 3 of the main menu.

Through this procedure it is possible to carry out the following actions on a USER transmitter, only if it is present in the memory:

- Modify the activated relay and the corresponding transmitter key;
- Enable or disable the single USER

M	O	D	I	F	Y	U	S	E	R						
U	S	E	R			S	N			2	0	6	0	9	

Set the Serial Number of the transmitter to modify by using the 3 methods allowed (TX MASTER, KEYPAD, Key B of the USER TX)

Then give the confirmation with the key YES of the TX MASTER

User Enable / Disable

The receiver checks the current situation and propose the corresponding chngement

- If the USER transmitter id enabled, it asks to disable;
- if the USER transmitter is enabled, it asks to enable

U	S	E	R				S	N			2	0	6	0	9
D	I	S	A	B	L	E	U	S	E	R		?			

With an answer YES the following message appears:

D	I	S	A	B	L	E	U	S	E	R					
A	R	E		Y	O	U		S	U	R	E		?		

With a final YES appears the message EXECUTED OK, the transmitter is disabled, the procedure ends and the program returns to the main menu.

If the transmitter is currently disabled, you are asked to enable.

U	S	E	R				S	N			2	0	6	0	9
E	N	A	B	L	E		U	S	E	R		?			

With an answer YES the following message appears:

E	N	A	B	L	E		U	S	E	R					
A	R	E		Y	O	U		S	U	R	E		?		

With a final YES appears the message EXECUTED OK, the transmitter is enabled, the procedure ends and the program returns to the main menu.

Modify relay or key parameters

Once selected the Serial Number of the transmitter to modify, you are asked to set the relay and the key parameters:

U	S	E	R				S	N			2	0	6	0	9
R	E	L	A	Y			O	R			K	E	Y		?

With a YES, it is displayed the current configuration of the transmitter: activated relay and corresponding transmitter key.

The following table shows the association between relays and keys when the parameter RELAY is set to 1/2:

2-keys transmitter

Key Option	A	B
Activations	A - Relay 1 B - Relay 2	B - Relay 1 A - Relay 2

4-keys transmitter

Key Option	A	B	C	D
Activations	A -Relay 1 B -Relay 2	B -Relay 1 C -Relay 2	C -Relay 1 D -Relay 2	D -Relay 1 A -Relay 2

U	S	E	R				S	N			2	0	6	0	9
R	E	L	A	Y	:	1/2					K	E	Y	:	A

If the parameter RELAY is set to 1 or 2, only the key indicated causes the activation of the relay.

Once inside the options for the parameters RELAY and KEY, scroll the options available with the LEFT key of the TX MASTER and confirm with the RIGHT key.

OPTIONS RELAY : 1 - 2- 1/2 - 1 - 2 - etc.

OPTIONI KEY : A - B - C - D - A - B - etc.

At the end the message EXECUTED OK appears and the program returns to the main menu.

NOTE : If you entry the S/N of a transmitter not in memory, the following message appears :

S	N			N	O	T				I	N			M	E	M	O	R	Y
U	S	E	R							S	N			2	0	6	0	9	

Copy and data transfer menu

Through this sub-menu it is possible:

- To visualize the memory on the display LCD;
- To print the list of the users;
- To program the Serial number of a transmitter;
- To copy the internal memory data onto a backup memory;
- To restore the data from a backup memory.

Menu structure

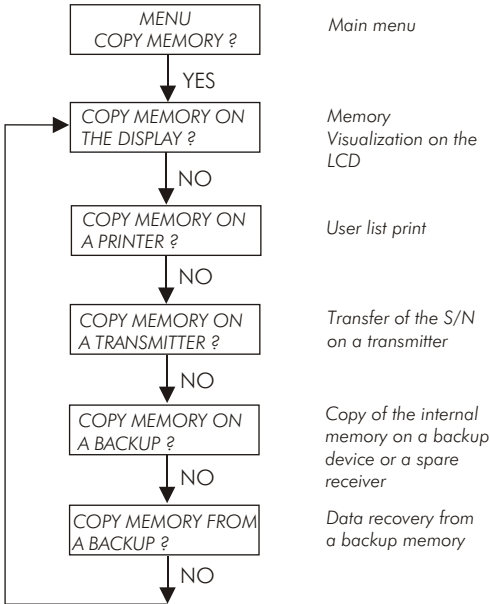

Memory Visualization on the LCD

The first option allows to visualize the data memory on the LCD display.

The visualization is carried out line for line : each line contains all the information of the USER: Serial number, abilitation, activated relays, corresponding transmitter key

The first and the last transmitter are marked as: FIRST USER e LAST USER.

Use the keys of the MASTER transmitter to scroll up and down the list, as shown below:

- RIGHT key TX MASTER : scroll down the list;
- LEFT key TX MASTER : scroll up the list;
- LEFT+RIGHT keys simultaneously : back to upper menu;

Example : visualization of a receiver memory with 3 transmitters (2 User and 1 Master) :

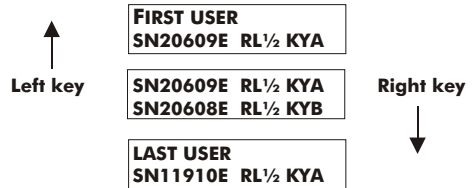

Print user list

With the choice "COPY MEMORY ON A PRINTER", it is possible to print the list of the users stored to a Serial Printer (see connector 9 at pag. 2)

The transfer parameters are the following:

BAUD RATE: 2400 BAUD
N BIT: 8
PARITY: NONE
STOP BIT: 1
HANDSHAKE: NONE

The data memory are transferred through the RS232C to the device connected to the D-type 9-pin male connector. It is possible to connect also a PC or a Terminal with VT100 emulation (see connection diagrams at pag. 19). After the selection confirmation, on the LCD will appear 2 messages:

during the printing: COPY
IN PROGRESS.....

at the end: COPY
EXECUTED OK

Then the program return to the initial message. The printout allows to complete the list by hand with more information as the user name and the installation address.

Print events

Each time a transmitter excites a relay, a string message is sent to the RS232 output. The format of the string is the following:

[CR] UAAAA - FBB- SCCCC - RD - KE [LF]

Legend:

[CR] = Carriage Return;
[LF] = Line Feed;
U, F, S, R, K, = Code Letters ;
AAAA = User Number (0000 - 0807)
BB = Facility Code (000 - 255);
CCCC = Serial Number (00000 - 65535) ;
D = Relay activated (1 or 2 or 1/2);
E = Transmitter key activated (A, B, C, D);
"- " = Blank .

Example

Transmitter received with S/N =05310, Facility code = 02, User number : 001 ;
Transmitter key activated = A , Relay activated = 1

Signal output :

[CR] U0001 - F02- S05310 - R1 - KA [LF]

Printout example

```
***   ERONE   433/800   ***  
  
PASSWORD : 11111  
  
FACILITY CODE : 000,00_  
  
USER ADDRESS  
  
-----  
to be filled by hand  
-----  

| USER N. | S/N   | STATUS | RELAY | KEYS |
|---------|-------|--------|-------|------|
| 0001    | 20609 | E      | 1 / 2 | A/B  |
| 0002    | 20608 | E      | 1     | B    |
| 0801    | 11910 | E      | 1 / 2 | A/B  |

  
USER NAME  
to be filled by hand  
  
*** End of List ***
```

Transmitter S/N configuration

Each transmitter is sold with a different Serial Number (S/N). It is anyway possible to change this number using the cable B with the special probe (see fig. on pag. 20). For this operation connect the cable to the receiver connector RJ11 (Ref. 7 on pag. 2). Select the option "Copy memory on a transmitter" :

C	O	P	Y	M	E	M	O	R	Y				
O	N	A	T	R	A	N	S	M	I	T	T	E	R

You are asked for the Serial Number to set on the transmitter

P	R	O	G	R	A	M	T	X					
U	S	E	R				S	N	0	0	6	0	9

Dial the desired S/N and confirm with the transmitter MASTER.

The display asks for the connection:

P	R	O	G	T	X	S	N	0	0	6	0	9	
C	O	N	N	E	C	T	E	D	?				

At this point open the battery door of the transmitter and connect the probe to the 7 pads present on the bottom of the transmitter card, as shown in fig. 13.

Confirm with the RIGHT key of the MASTER transmitter.

The software begins the check of the connection:

P	R	O	G	T	X	S	N	0	0	6	0	9	
V	E	R	I	F	Y	.	.	.					

Finally on the display appears the message : EXECUTED OK. The procedure asks for another S/N to set and propose the number next to the last S/N used .

NOTE:

- 1) The S/N : "00000" cannot be used. The receiver gives an error message;
- 2) The Facility Code memorized with the S/N is the same of the first transmitter memorized which is allocated on the position 1 of the memory
- 3) If the data transfer hasn't carried out successfully, on the display appears the message "CONNECTED?" again.

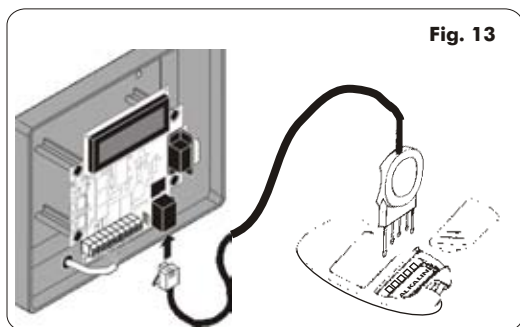

Data transfer from and to a backup device

Through these 2 sub-menu it is possible to copy the entire memory data onto a backup device (a backup memory or a spare receiver) or restore the data from a backup device.

For a backup device it is possible to use the backup memory (see. fig. 18 on pag. 19).

This has to be inserted on the 4-ways strip connector (ref. 6 on pag. 2) respecting the insertion sense.

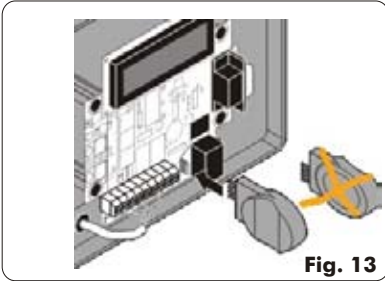

Fig. 13

As backup device it is also possible to use a spare receiver and connect the 2 appliances with a 4 net telephone cable with RJ11 connectors

(See Fig. 16 on pag. 19).

See the connection below on fig.14

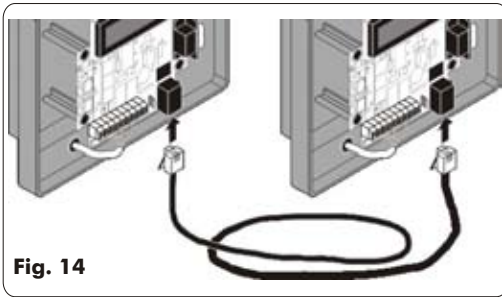

Fig. 14

Data transfer to a backup memory

Select the option:

C	O	P	Y	M	E	M	O	R	Y	O	N		
A		B	A	C	K	U	P	?					

The receiver perform a first test (on the strip connector and on the telephone connector) to verify the backup device presence.

If the test fails the following message appears on the LCD

C	O	P	Y	M	E	M	O	R	Y	O	N		
N	O	T		C	O	N	N	E	C	T	E	D	!

Insert the memory or connect the telephone cable and confirm with the RIGHT key of the TX MASTER.

A warning message will appear:

M	E	M	O	R	Y	B	U	S	Y				
D	E	L	E	T	E	?							

The message warns that the destination memory will be fully overwritten.

With a further confirmation the transfer begins.

During the transfer on the LCD appears the message:

T	R	A	N	S	F	E	R						
I	N		P	R	O	G	R	E	S	.	.		

If the transfer is completed successfully, appears the message: EXECUTED OK and the buzzer emits 2 beeps.

Data transfer from a backup memory

Select the option:

C	O	P	Y	M	E	M	O	R	Y	F	R	O	M
A		B	A	C	K	U	P	?					

The procedure is quite similar to the previous.

From this time on the sequence of messages is similar to the other.

In this case the internal memory data are fully overwritten by the external data (from the backup memory or from the spare receiver memory).

WARNING : Use this option carefully : if the external device data are corrupted or non updated, your data base could be unrecoverable lost.

Receiver configuration memu

In this sub-menu you find the options for :

- Password modification;
- Relay1 configuration setup;
- Relay2 configuration setup;
- Facility Code 1 setting;
- Facility Code 2 setting.

Menu structure

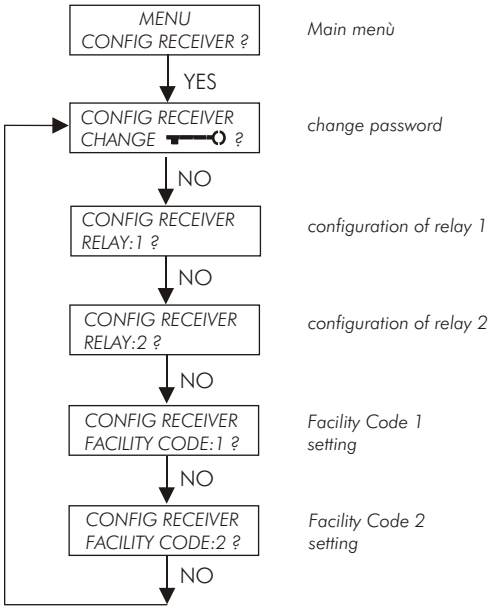

Change password

Select this option to change the current password and the following message will appear on the display:

C	O	N	F	I	G	R	E	C	E	I	V	E	R
C	H	A	N	G	E							?	

Confirm with the RIGHT key of the MASTER transmitter. The password settings can be as follows:

1) The current password is Null ("00000"): password disabled.

In this case you are asked for the new password (see below). Entry twice the same number.

N	E	W											
I	N	S	E	R	T					0	0	0	0

N	E	W											
C	O	N	F	I	R	M				0	0	0	0

2) The current e password is different from the Null ("00000"): Password enabled.

In this case you are asked first to compose the current password and then to compose twice the new one (see below).

C	U	R	R	E	N	T							
I	N	S	E	R	T					0	0	0	0

N	E	W											
I	N	S	E	R	T					0	0	0	0

N	E	W											
C	O	N	F	I	R	M				0	0	0	0

NOTE:

1) Null Password ("00000") means Password disabled. When the password is set to a value different from Null ("00000") on the display appears the message:

ENABLED 
EXECUTED OK

When the password is set to a value Null ("00000") on the display appears the message:

DISABLED 
EXECUTED OK

2) The receiver is sold with the preset-in-factory default Password ("11111").

Relay configuration (Relay1 and Relay 2)

The operating mode of the two relays can be set in separate way.

Each relay can be configured as follows:

- **PULSE** - *Pulse operating mode*: the relay excites at the reception of a good transmitter signal and remains excited until the transmitter key is released.
- **STEP** - *Bistable operating mode* : the relays excites at the first pulse and releases at the next one
- **TIMED 6 SECONDS** - *Timed operating mode*: at the end of the received signal the relay remains excited for further 6 seconds.
- **SHORT RANGE** - *"Pedestrial operating mode"* :in this case the receiver sensitivity is reduced of 40 dB causing a big reduction of the radiocontrol range (Final range of about max 10 mt.)

Structure of the sub-menu

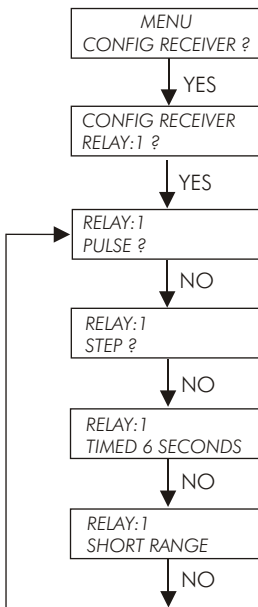

Select the RELAY 1 or RELAY 2 configuration using the LEFT Key of the MASTER transmitter and confirm with the RIGHT key : the display will give the message: EXECUTED OK and the program will return to the main menu.

Facility Code set-up

The "Facility Code " (FC) is a number, in the range : "000" to "256", sent by the transmitter with its own Serial Number (S/N).

The receiver is programmed to accept only transmitters which have 2 types of Facility Codes.

Any transmitter with facility code different from the 2 programmed won't be accepted.

Through the following procedure it is possible to set the couple of Facility Codes.

Select the option : FACILITY CODE : 1? from the receiver configuration menu using the LEFT key of the MASTER transmitter..

Confirm the choice and you will be asked for the new Facility Code.

The message prompts with the current number memorized for the Facility Code 1

F	A	C	I	L	I	T	Y		C	O	D	E	:	1		
C	H	E	C	K		F	O	R						0	0	1

You are asked to change or confirm the memory settings. In the case above, the receiver accepts only transmitters with Facility code = 001.

Config the Facility Code making use of the MASTER transmitter, or the KEYPAD or by using the key B of a transmitter with the desired Facility code.

At the end appears the message: **EXECUTED OK** and the program return to the main menu.

The procedure to set the Facility Code 2 is similar to the other.

On the display will appear "Facility Code 2".

F	A	C	I	L	I	T	Y		C	O	D	E	:	2		
C	H	E	C	K		F	O	R						0	0	1

NOTE : the Facility code Null ("000") has a special meaning.

In this case the Facility Code check is completely disabled.

Number of the stored USER transmitters

At the point N° 6 of the main menu, the program shows the number of the USER transmitters present in the memory.

This number refers only to the USER transmitters and not to the MASTER transmitters, which can be up to 7.

This number is updated after any variation (new memorization / cancellation, memory initialization).

Receiver auto-test system

The Erone 433/800 receiver contains an auto-test system which makes it possible to identify incorrect usages or readings.

Example of the message on the display:

**SYSTEM
ERROR**

CODE	DESCRIPTION	ACTION
1	Impossible to write on the memory	Memory empty. Return the receiver to the factory
2	Reading or writing error on the display	Copy the contents of the receiver to the backup and memory and return the receiver to the factory.
4	Faulty transfer of the data to a transmitter via connecting cable	Repeat the programming of the transmitter. If the message is persistent, check the memory position on the receiver, memorize again, and then start transfer again.
8 16	Used for checking during production Used for checking during production	
32	Writing on the last memory position Es. 800 or 812.	Memory full Last memory position: use a previous position or replace a position already used.
64	Radio signal received too weak	Check the charge on the batteries of the transmitter or bring the transmitter near the receiver
128	Transmitter counter not synchronized	Transmit a second time If the message persists, eliminate the memory position of the transmitter and then memorize again. If, after the transfer of a transmitter, the number of impulses allowed (16) has been exceeded, the counter will no longer be synchronized and the transmitter cannot be memorized in the receiver.

RS232 Connection

The receiver can be connected to a terminal (VT100) to a PC or to a serial printer through a 9-ways D-type male connector. The interface is a RS232C with the following parameters:

Baud-rate: 2400 Baud
N° bits: 8
Parity: None
Stop bits: 1

Signal	Pin connection
RD (Receive Data)	2
TD (Transmit Data)	3
SG (Signal Ground)	5

According to the connected device, the connecting cable has to be as follows:

1) Connection Receiver RCS-433BMR - PC Serial Port (D-type 9 pin Male connector)

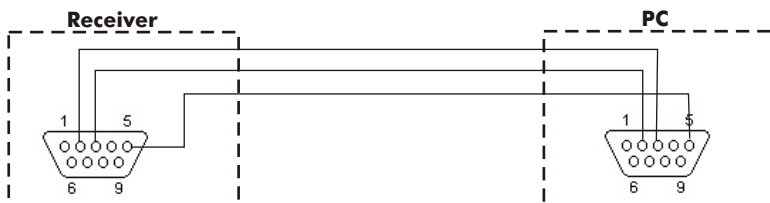

2) Connection RCS-433BMR - PC Serial Port (D-type 25 pin Male connector)

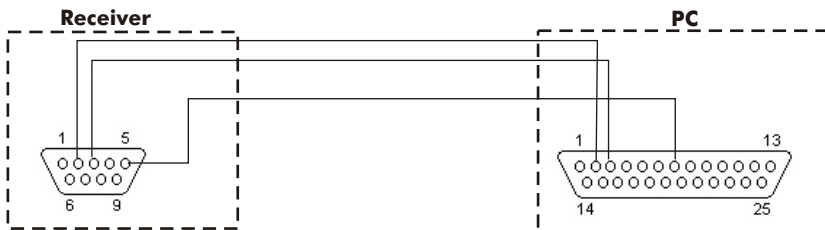

3) Connection RCS-433BMR - Printer Serial Port (D-type 25 pin Female connector)



4) Connection RCS-433BMR - Printer Serial Port (D-type 9 pin Female connector)

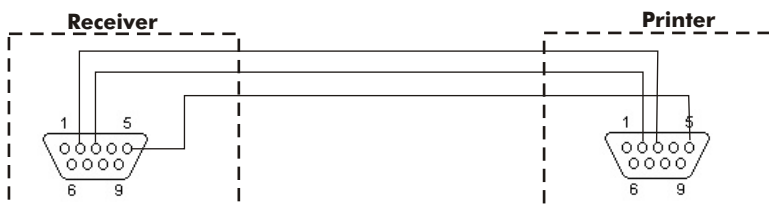

Accessories

For the functionality of the receiver the following accessories are available:

- A) TX PROGRAMMING CABLE with PROBE (Fig. 15)
- B) CONNECTION RECEIVER - RECEIVE CABLE (fig. 16)
- C) SERIAL CABLE to a serial printer (Fig. 17)
- D) BACKUP MEMORY (Fig. 18).



ERONE is a trademark ELPRO INNOTEK S.p.A.

GUARANTEE

ELPRO INNOTEK S.p.A.
Via Piave, 23
31020 S. Pietro di Feletto (TV) - ITALY
Tel. +39.0438.450.879 Fax +39.0438.455.628
E-mail: info@erone.com
Web: www.erone.com

Warranty period : 24 months from the production date placed inside. In this period if the appliance has any malfunction due to defective component, it will be repaired or replaced by the manufacturer. The warranty doesn't cover the plastic box The assistance will be performed at the manufacturer site.